

## MAGIQ 4 CELL RECESSED

### A35142-

base number    Color    Finishes    Reflector    Finish  
 Temperature    (Diamond)    Options    Options

- To build a product code in our configurator select the specify button on the base model # product page
- To build a manual product code on this datasheet choose from the options listed below in blue font and add the suffix to the base model #

#### GENERAL

Series: Magiq  
 Subseries: Magiq 4 Cell  
 Partner: Prolicht  
 Division: Architectural  
 Installation: Recessed  
 Product Type: Downlight  
 Mounting Location: Ceiling  
 Light Distribution: Downlight

#### PHYSICAL

Aperture Sizes - Downlights: 1"  
 Shape: Rectangle  
 Length (mm): 145  
 Length (in): 5 11/16  
 Width (mm): 45  
 Width (in): 1 3/4  
 Height (mm): 64  
 Height (in): 2 1/2  
 Ceiling Thickness (mm): 10 / 12.5 / 15 / 25 / 30  
 Ceiling Thickness (in): 3/8 or 1/2 or 9/16 or 1 or 1 3/16  
 Min. Recessing Depth (mm): 100  
 Min. Recessing Depth (in): 3 15/16  
 Weight (kg): 0.265  
 Weight (lbs): 0.58  
 Fixture Finish: SSR / BKV / CWI / CRY / HAB / UFT / ITA / RUA / FTG / MYG / LOD / PUS / FRO / FUP / KIA / POP / BLS / SPG / MEY / GOH / CHC / COM / ABZ / JAG / OBR / MOS / ROR  
 Holder Finish: WHI / BLK  
 Fixture Material: Aluminum Die Cast  
 Cut-out Measurements: 138mm / 5 7/16" x 38mm / 1 1/2"

#### ELECTRICAL

Lamp Type: LED (Zhaga Standard)  
 Input Wattage (W): 14.3  
 Total Output Wattage (W): 13.3  
 Dimming: Tri-Mode (Non-Dimming and Phase Dimming (120Vac only) and 0-10V Dimming)  
 Driver Included: No  
 Driver Location: Remote  
 Driver Type: Constant Current - Universal  
 Driver Class: Class 2  
 Input Voltage (V): 120 - 277  
 Constant Current (MA): 1050  
 Upon Request: Lutron

#### LED

Number of LEDs: 4  
 Color Temperature (°K): 2700 / 3000 / 3500 / 4000  
 Max. Delivered Lumen (lm): Max 781 / 843 / 860 / 878  
 Nominal Lumen (lm): 880 / 954 / 970 / 990  
 CRI: >90 CRI  
 Lamp Life (hrs): 50000

#### OPTICAL

Reflector: 8 / 14 / 34

#### RATINGS AND CERTIFICATIONS

Certified By: CSA Certified to UL and CSA Standards

IP rating: IP20  
 Zaneen Corporation © 2026, T 1800-388-3382, F 416-247-9319, www.zaneen.com

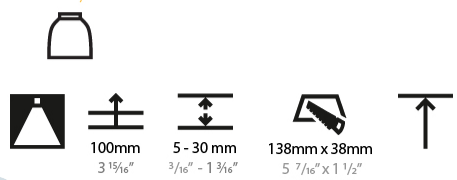
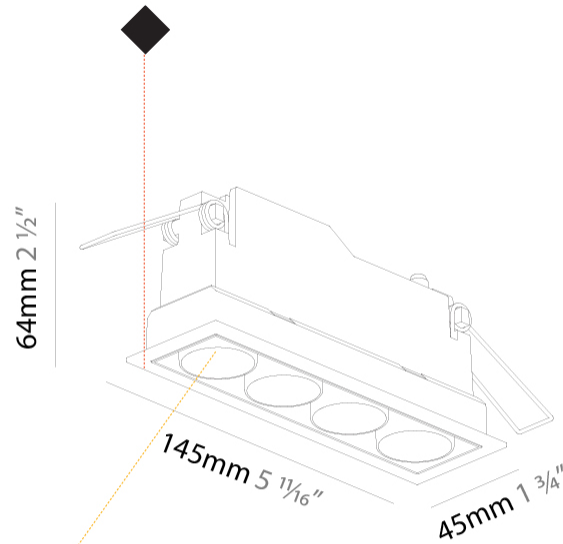

## MAGIQ 4 CELL RECESSED

A35142-

PROJECT \_\_\_\_\_

TYPE \_\_\_\_\_

SPECIFIER \_\_\_\_\_

QUANTITY \_\_\_\_\_

DATE \_\_\_\_\_

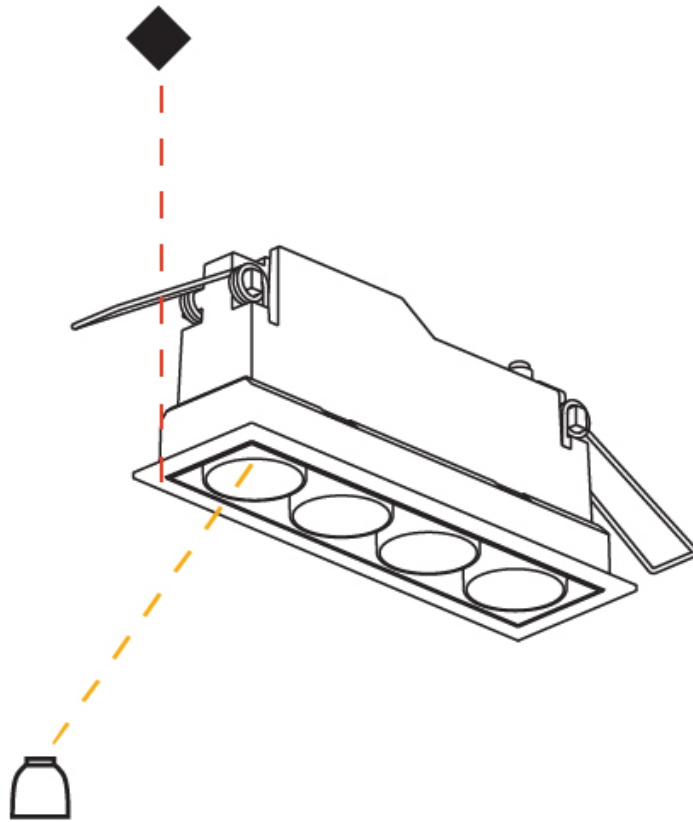

## MAGIQ 4 CELL RECESSED

**A35142- : A35142-30K-02-34-02**

base number

- To build a product code in our configurator select the specify button on the base model # product page
- To build a manual product code on this datasheet choose from the options listed below in blue font and add the suffix to the base model #

### GENERAL

Series: Magiq \_\_\_\_\_  
 Subseries: Magiq 4 Cell \_\_\_\_\_  
 Partner: Prolicht \_\_\_\_\_  
 Division: Architectural \_\_\_\_\_  
 Installation: Recessed \_\_\_\_\_  
 Product Type: Downlight \_\_\_\_\_  
 Mounting Location: Ceiling \_\_\_\_\_  
 Light Distribution: Downlight \_\_\_\_\_

### PHYSICAL

Shape: Rectangle \_\_\_\_\_  
 Length (mm): 145 \_\_\_\_\_  
 Length (in): 5 <sup>11</sup>/<sub>16</sub> \_\_\_\_\_  
 Width (mm): 45 \_\_\_\_\_  
 Width (in): 1 <sup>3</sup>/<sub>4</sub> \_\_\_\_\_  
 Height (mm): 64 \_\_\_\_\_  
 Height (in): 2 <sup>1</sup>/<sub>2</sub> \_\_\_\_\_  
 Min. Recessing Depth (mm): 100 \_\_\_\_\_  
 Min. Recessing Depth (in): 3 <sup>15</sup>/<sub>16</sub> \_\_\_\_\_  
 Fixture Material: Aluminum Die Cast \_\_\_\_\_  
 Cut-out Measurements: 138mm / 5 7/16" x 38mm / 1 1/2" \_\_\_\_\_

### ELECTRICAL

Lamp Type: LED (Zhaga Standard) \_\_\_\_\_  
 Input Wattage (W): 14.3 \_\_\_\_\_  
 Total Output Wattage (W): 13 \_\_\_\_\_  
 Dimming: Tri-Mode (Non-Dimming and Phase Dimming (120Vac only) and 0-10V Dimming) \_\_\_\_\_  
 Driver Included: No \_\_\_\_\_  
 Driver Location: Remote \_\_\_\_\_  
 Driver Type: Constant Current - Universal \_\_\_\_\_  
 Driver Class: Class 2 \_\_\_\_\_  
 Input Voltage (V): 120 - 277 \_\_\_\_\_  
 Constant Current (MA): 1050 \_\_\_\_\_

### LED

Number of LEDs: 4 \_\_\_\_\_  
 Color Temperature (°K): 3000 \_\_\_\_\_  
 Max. Delivered Lumen (lm): 843 \_\_\_\_\_  
 Nominal Lumen (lm): 954 \_\_\_\_\_  
 CRI: >90 CRI \_\_\_\_\_  
 Lamp Life (hrs): 50000 \_\_\_\_\_

### OPTICAL

Reflector: 34 \_\_\_\_\_

### RATINGS AND CERTIFICATIONS

Certified By: CSA Certified to UL and CSA Standards \_\_\_\_\_  
 IP rating: IP20 \_\_\_\_\_

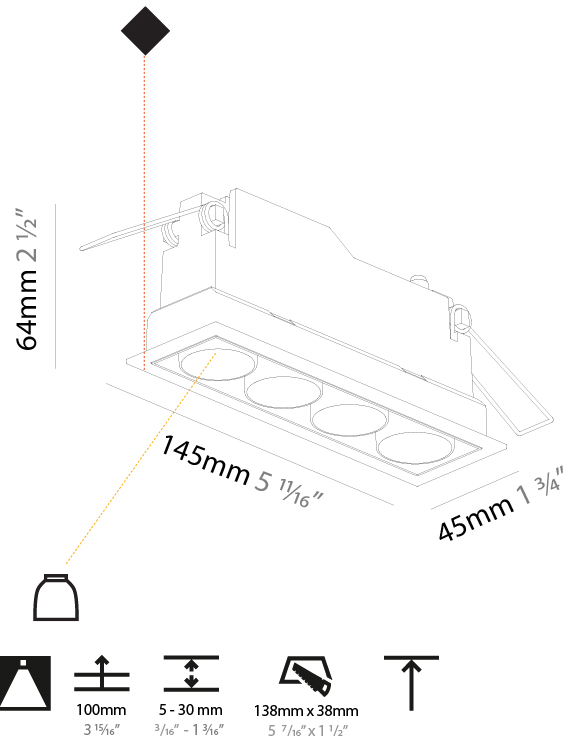

## MAGIQ 4 CELL TRIMLESS

### A35498-

base number    Color    Finish    Reflector  
 Temperature    Options    Options

- To build a product code in our configurator select the specify button on the base model # product page
- To build a manual product code on this datasheet choose from the options listed below in blue font and add the suffix to the base model #

#### GENERAL

Series: Magiq  
 Subseries: Magiq 4 Cell  
 Partner: Prolicht  
 Division: Architectural  
 Installation: Trimless  
 Product Type: Downlight  
 Mounting Location: Ceiling  
 Light Distribution: Downlight

#### PHYSICAL

Aperture Sizes - Downlights: 1"  
 Shape: Rectangle  
 Length (mm): 135  
 Length (in): 5 <sup>5</sup>/<sub>16</sub>"  
 Width (mm): 35  
 Width (in): 1 <sup>3</sup>/<sub>8</sub>"  
 Height (mm): 65  
 Height (in): 2 <sup>9</sup>/<sub>16</sub>"  
 Ceiling Thickness (mm): 12.5  
 Ceiling Thickness (in): 1/2  
 Min. Recessing Depth (mm): 100  
 Min. Recessing Depth (in): 3 <sup>15</sup>/<sub>16</sub>"  
 Weight (kg): 0.403  
 Weight (lbs): 0.89  
 Fixture Finish: [BLK / WHI](#)  
 Fixture Material: Aluminum Die Cast  
 Cut-out Measurements: 142mm / 5 9/16" x 42mm / 1 5/8"  
 Upon Request: Unique Ceiling Thickness

#### ELECTRICAL

Lamp Type: LED (Zhaga Standard)  
 Input Wattage (W): 14.3  
 Total Output Wattage (W): 13.3  
 Dimming: Tri-Mode (Non-Dimming and Phase Dimming (120Vac only) and 0-10V Dimming)  
 Driver Included: No  
 Driver Location: Recessed Housing  
 Driver Type: Constant Current - Universal  
 Driver Class: Class 2  
 Housing: See components  
 Input Voltage (V): 120 - 277  
 Constant Current (MA): 1050

#### LED

Number of LEDs: 4  
 Color Temperature (°K): [2700 / 3000 / 3500 / 4000](#)  
 Max. Delivered Lumen (lm): 750 / 850 / 862 / 880  
 CRI: >90 CRI  
 Lamp Life (hrs): 50000  
 Upon Request: Special Color Temperature

#### OPTICAL

Reflector: [8 / 18 / 34](#)  
 Upon Request: Special Beam Angles

#### RATINGS AND CERTIFICATIONS

Certified By: CSA Certified to UL and CSA Standards  
 IP rating: IP20

Zaneen Group Inc. © 2026, T 1800-388-3382, F 416-247-9319, www.zaneen.com

Available for International specifications by adding 'INT' at the end of the existing Model #. For assistance on 'custom' specifications, contact zteam@zaneen.com. In a constant effort to supply the best product, we reserve the right to change specifications or materials without notice. The most recent specification sheets are found at zaneen.com

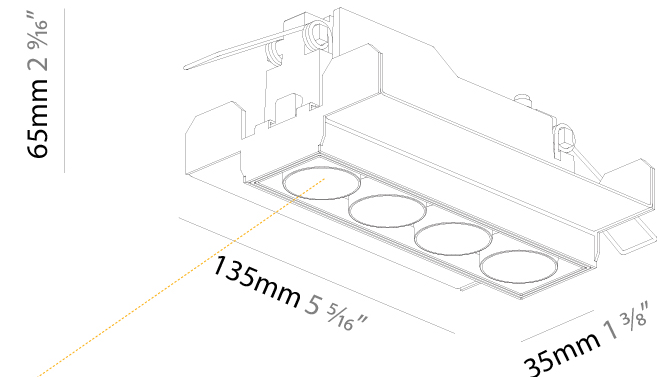
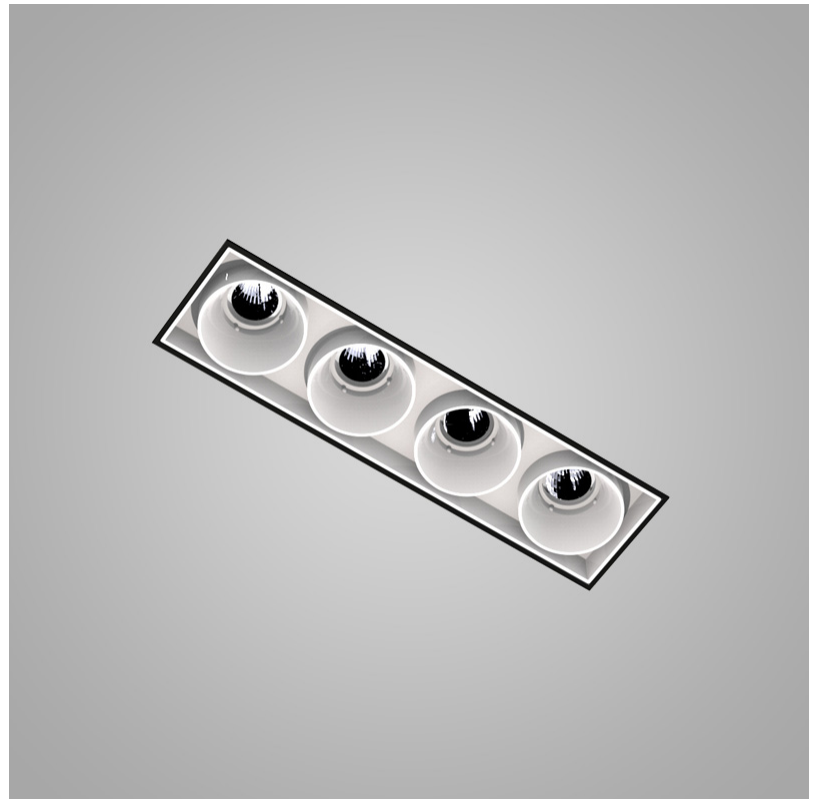

## MAGIQ 4 CELL TRIMLESS

A35498-

PROJECT	_____
TYPE	_____
SPECIFIER	_____
QUANTITY	_____
DATE	_____

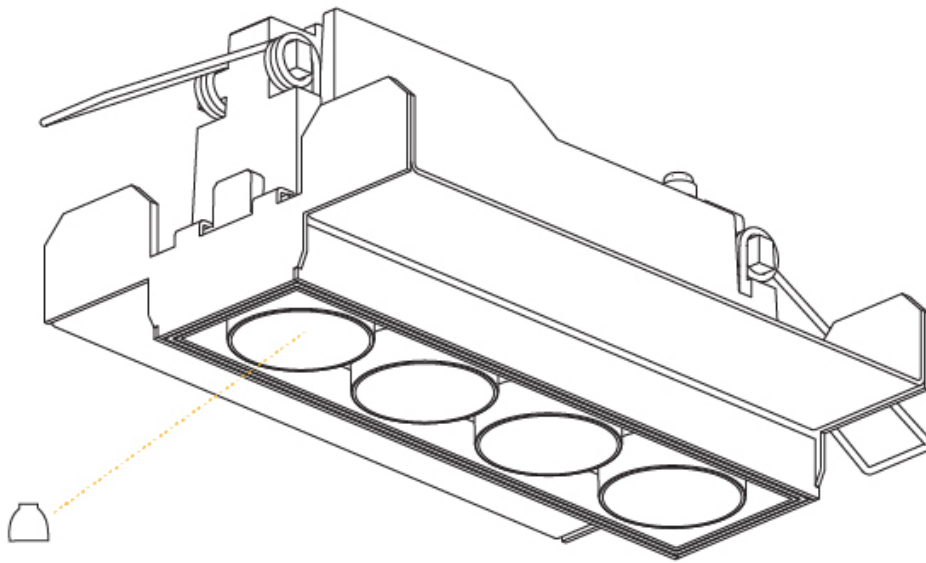

PROJECT	_____
TYPE	_____
SPECIFIER	_____
QUANTITY	_____
DATE	_____

## MAGIQ 4 CELL SURFACE

### A3D184-

base number	Color	Finishes	Finish	Reflector
	Temperature	(Diamond)	Options	Options

- To build a product code in our configurator select the specify button on the base model # product page
- To build a manual product code on this datasheet choose from the options listed below in blue font and add the suffix to the base model #

#### GENERAL

Series: Magiq  
 Subseries: Magiq 4 Cell  
 Partner: Prolicht  
 Division: Architectural  
 Installation: Surface  
 Product Type: Ceiling Surface  
 Mounting Location: Ceiling  
 Light Distribution: Direct

#### PHYSICAL

Shape: Rectangle  
 Length (mm): 142  
 Length (in): 5 <sup>5</sup>/<sub>16</sub>  
 Width (mm): 42  
 Width (in): 1 <sup>5</sup>/<sub>8</sub>  
 Height (mm): 109  
 Height (in): 4 <sup>3</sup>/<sub>16</sub>  
 Weight (kg): 0.65  
 Fixture Finish: SSR / BKV / CWI / CRY / HAB / UFT / ITA / RUA / FTG / MYG / LOD / PUS / FRO / FUP / KIA / POP / BLS / SPG / MEY / GOH / CHC / COM / ABZ / JAG / OBR / MOS / ROR  
 Holder Finish: WHI / BLK  
 Fixture Material: Aluminum Die Cast

#### ELECTRICAL

Lamp Type: LED (Zhaga Standard)  
 Input Wattage (W): 13  
 Total Output Wattage (W): 11.8  
 Dimming: Tri-Mode (Non-Dimming and Phase Dimming (120Vac only) and 0-10V Dimming)  
 Driver Included: Yes  
 Driver Location: Integrated  
 Driver Type: Constant Current - Universal  
 Driver Class: Class 1  
 Input Voltage (V): 120 - 277  
 Constant Current (MA): 1050mA

#### LED

Number of LEDs: 4  
 Color Temperature (°K): 2700 / 3000 / 3500 / 4000  
 Max. Delivered Lumen (lm): 781 / 843 / 860 / 878  
 Nominal Lumen (lm): 880 / 950 / 970 / 990  
 CRI: >90 CRI  
 Efficiency (%): 80  
 Lamp Life (hrs): 50000

#### OPTICAL

Reflector: 8 / 14 / 34  
 Adjustability: Fixed

#### RATINGS AND CERTIFICATIONS

Certified By: Certified for North American Standards  
 IP rating: IP20

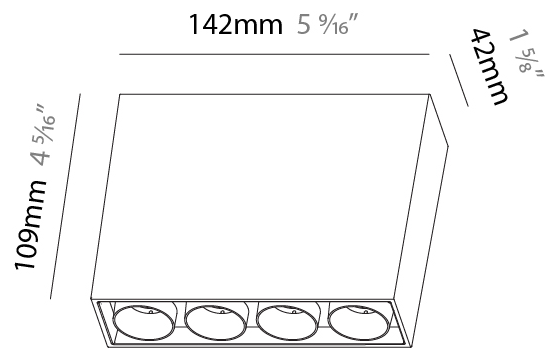

## MAGIQ 4 CELL SURFACE

A3D184-

PROJECT	_____
TYPE	_____
SPECIFIER	_____
QUANTITY	_____
DATE	_____

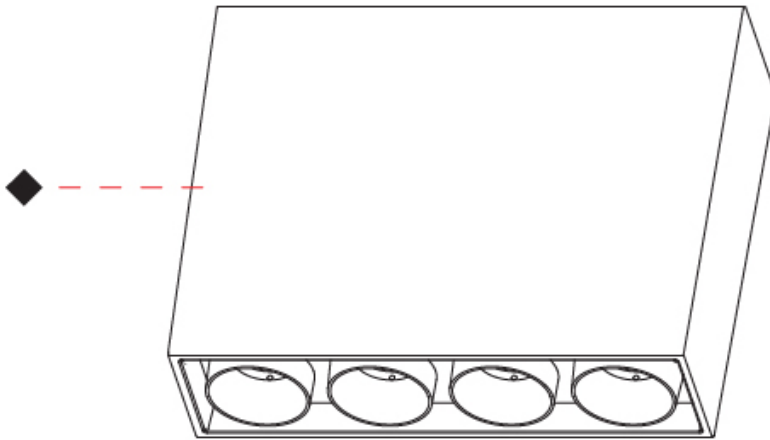

A

## MAGIQ COLOR FINISH CHART

PROJECT \_\_\_\_\_  
 TYPE \_\_\_\_\_  
 SPECIFIER \_\_\_\_\_  
 QUANTITY \_\_\_\_\_  
 DATE \_\_\_\_\_

### Fixture Finish







































































### Holder Finish











PROJECT	
TYPE	
SPECIFIER	
QUANTITY	
DATE	











### LEGEND

	floor-mounted		pivotal		special LED (upon request) RGB, RGBW, tunable, gold+, meat+, art+, fashion+
	wall and ceiling: recessed and surface mounted		rotating		warm dim / natural dimming LED
	ceiling-mounted and wall-mounted		illuminate tilted		rechargeable battery powered
	wall-mounted		color of suspension cable		fixture with natural vivid LED (upon request)
	omni-directional light distribution		length of suspension cable		color rendering index
	direct light distribution		reflector degree selection		color temperature
	direct/indirect light distribution		super spot		lumen (luminous flux)
	indirect light distribution		lens		efficacy (lumens per watt)
	asymmetric light distribution		lens pack		Unified Glare Rating (UGR) range from 5-40
	aura light distribution		shine ring		marine grade (AISI 316 stainless steel)
	round wall or ceiling cut-out		integrated shine ring with diffuser		walk on
	square wall or ceiling cut-out		free individual colors 01-29		drive on
	the supplied jig specifies the cutout dimensions		individual colors: 00 (free of charge), 01-25 (extra charge)		Dark Sky Compliance
	minimum distance (meters) lamp - object		luminaire part to be colored (F1)		Americans with Disabilities Act (less than 4" off the wall located between 27"-84" from floor)
	recessed depth		luminaire part to be colored (F2)		lamp protected against explosion
	ceiling thickness in mm		luminaire part to be colored (F3)		blown glass using traditional methods by master glass blower
	ceiling thickness selection		luminaire part to be colored (F4)		acoustic material
	dimnable DP (phase), DV (0-10V), DD (dali), DS (step-dim)		luminaire part to be colored (F5)		protection class I, protection insulation
	included or excluded LED driver/transformer/control gear		color of 3-circuit adaptor		protection class II, protection insulation
	separately switchable		indirect diffuser		ETL Certified to UL and CSA Standards
	sensor		direct diffuser		UL Certified to UL and CSA Standards
	remote control		ball-proof (upon request)		CSA Certified to UL and CSA Standards
	available upon request		accessory		Certified for North American Standards

### IP RATING

	protected against ingress of solid bodies greater than 12.5mm (finger)
	protected against ingress of solid bodies greater than 2.5mm protected against sprays of water up to 60 degrees from the vertical (rain)
	protected against ingress of solid bodies greater than 1mm (wire) no protection against the ingress of moisture
	protected against ingress of solid bodies greater than 1mm (wire) protected against sprays of water up to 60 degrees from the vertical (rain)
	protected against ingress of solid bodies greater than 1mm (wire) protected against water splashed from all directions
	protected against limited ingress of dust (wet rooms/covered outdoor areas) protected against water splashed from all directions
	protected against ingress of dust protected against jets of water
	protected against ingress of dust protected against powerful jets of water or heavy seas
	protected against ingress of dust protected against immersion of water between 15cm - 1m for 30 minutes
	protected against ingress of dust protected against immersion of water under pressure for long periods

### IK RATING

	protected against 0.14 joules impact (equivalent to 0.25kg mass dropped from 56mm above the surface)
	protected against 0.2 joules impact (equivalent to 0.25kg mass dropped from 80mm above the surface)
	protected against 0.35 joules impact (equivalent to 0.25kg mass dropped from 140mm above the surface)
	protected against 0.5 joules impact (equivalent to 0.25kg mass dropped from 200mm above the surface)
	protected against 0.7 joules impact (equivalent to 0.25kg mass dropped from 280mm above the surface)
	protected against 1 joules impact (equivalent to 0.25kg mass dropped from 400mm above the surface)
	protected against 2 joules impact (equivalent to 0.5kg mass dropped from 400mm above the surface)
	protected against 5 joules impact (equivalent to 1.7kg mass dropped from 300mm above the surface)
	protected against 10 joules impact (equivalent to 5.0kg mass dropped from 200mm above the surface)
	protected against 20 joules impact (equivalent to 5.0kg mass dropped from 400mm above the surface)